

# BLANCO



Performance First

---

Instructions for the Use and Care and Installation of

**BFWM7**

7Kg Front Load Washing Machine

---

Dear Customer

You will find that the clean lines and modern look of your **Blanco** Front Load Washing Machine blends in perfectly with your laundry décor. It is easy to use and performs to a high standard.

Blanco also makes a range of products that will enhance your kitchen – such as ovens, rangehoods, microwaves, sinks and taps.

Of course, we make every effort to ensure that our products meet all your requirements, and our Customer Relations Department is at your disposal, to answer all your questions and to listen to all your suggestions.

Please complete the warranty section of this manual and keep your receipt as proof of purchase. Retain all documents relating to the purchase of Blanco product.

Blanco is committed to providing increasingly efficient products that are easy to use, respect the environment and are attractive and reliable.

**BLANCO**



# CONTENTS



Part 1:  
Technical features.

Part 2:  
Steps before operating Fullautomatic  
Washing Machine and safety precautions.

Part 3:  
Determining Location and Installation

Part 4:  
Preparation



Part 5:  
Program Selection and Washing  
Machine Operation

Part 6:  
Care and Maintenance

Part 7:  
Before Calling Service

**General Warnings.**

- The appliance is not intended for use by young children or infirm persons without supervision.
- Young children should be supervised to ensure that they do not play with the appliance.
- If the appliance installed above carpet, please ensure that the carpet does not obstruct the openings
- If the supply cord is damaged, it must be replaced by the manufacturer or its service agent or a similarly qualified person in order to avoid a hazard.
- CAUTION: If the appliance is supplied from a cord extension set or an electrical outlet device, the cord extension socket or electrical portable outlet device must be positioned so that it is not subject to splashing or ingress

# Part 1: | Technical features

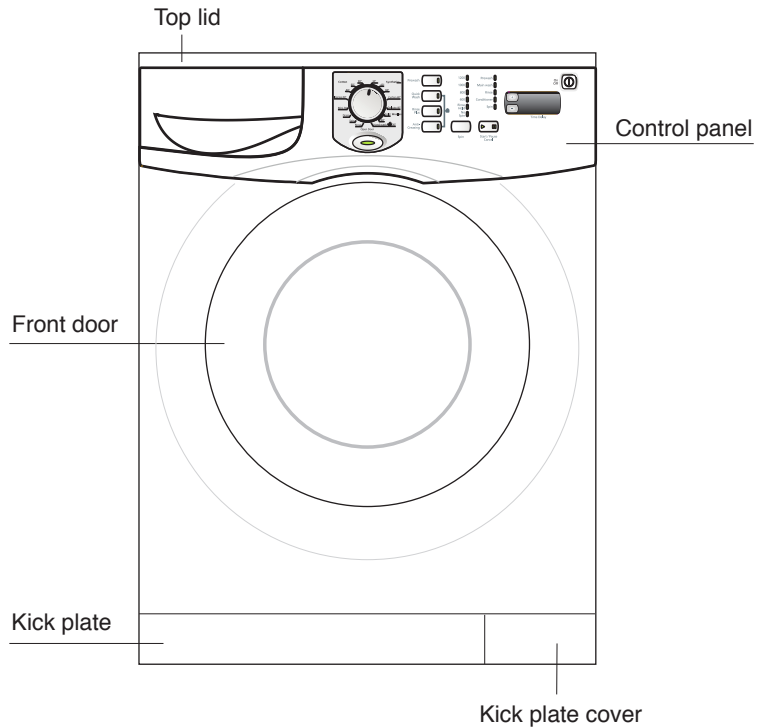

Capacity (dry fabric)	7 kg.
Height	85 cm.
Width	60 cm.
Depth	59 cm.
Net weight	76 kg.
Power requirement	240 V, 50 Hz.
Nominal current	10 A.
Power	2350 Watts.
Washing speed	52 rpm.
Spin speed	1200 rpm.



The appearance and specifications are subject to change without notice to raise the unit quality. The graphics shown in the manual are schematic and it is possible that they not conform with your washing machine.

## Part 2: Steps before operating Fullautomatic Washing Machine and safety precautions.

- The current requirement in order for safe operation of this machine is 10 Amp
- Your washing machine is set to 240 Volts.
- Do not forget to check the grounding in all cases of use Our company will not be responsible for any damages caused by operations without grounding.
- The performance of the washing machine depends on the effectiveness of the cleaning agent. Stains can be permanent if low quality detergents are used. Please take necessary effort to clean the stained clothes as described in following pages before washing them in the machine.
- Your washing machine is designed only for domestic use.
- If the power cord or the plug is damaged, please call a certified technician.
- Always use new "water inlet hose" received within your machine.
- Please perform the first wash with detergent, at COTTON 90 program and without placing your laundry inside the washing machine. This will ensure that the drum is free from any left over dirt from production .



Due to the quality control processes during production, there may be some water left over in your machine. This does not cause any damage to your product.

## Part 3: | Determining location and installation

### 1. Removing transport safety bolts at the rear of the machine

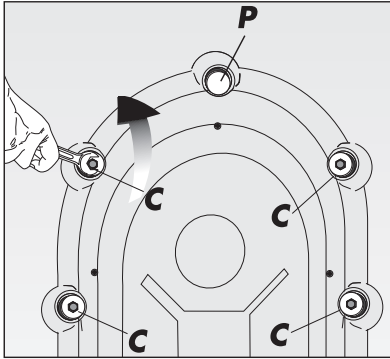

The transport safety bolts must be removed before any operation of the machine. Bolt heads, marked "C".

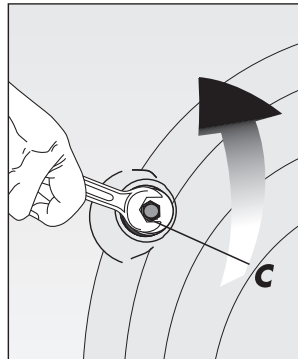

"C", should be turned in a anti clockwise direction until the bolt can be partially withdrawn.

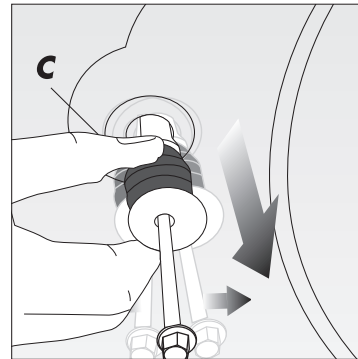

Remove transport safety bolts and rubber bushes by pulling outwards. (A up/down action and a small squirt of washing up liquid should ease removal.)

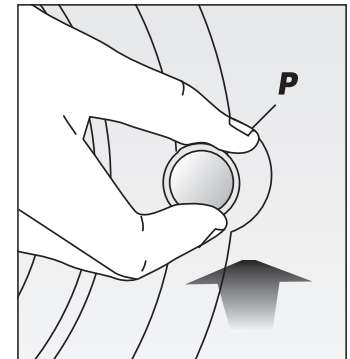

Plastic plugs, supplied inside the protective bag and designated as "P", should be placed in the safety bolt holes according to the direction shown.



#### Attention!

Please keep the safety bolts for future transportation and reinstate them before transporting your machine. Never transport your machine without the transport bolts in position.

Never place your machine on a carpet. This prevents air circulation. The electrical components of the machine may overheat and may cause damage.

## 2. Feet adjustment

In order for quiet and stable operation, the machine should be placed properly and levelled on its feet. Your machine comes with two adjustable feet. If the machine is unstable, loosen the plastic counter nut and screw or unscrew the adjustable foot until the machine is levelled perfectly. After positioning, tighten the counter nut for stability.

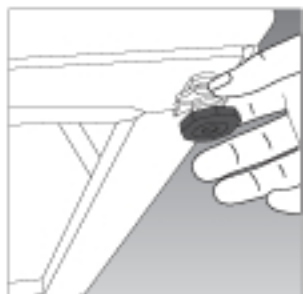

## 3. Water connections

### a) Water inlet hose

#### Cold water supply

For proper operation, the pressure of water should be between 100 kPa and 1000 kPa

To prevent water leaks sealing washers are supplied with the water inlet hose inside the machine, place these on each of the hose ends and tighten both ends fully.

In order to prevent any water leak damages, keep the water taps closed when not in use. Connect the cornered end of the hose to the machine water inlet.

#### Hot water supply (only for hot and cold water inlet machines)

Pressure: 100 -1000 kPa Temperature: 60°C max. A hot water supply fed from a separate cold water tank will normally be suitable. Open outlet gas or electric water heaters must not be used. Multipoint water heaters or combination boilers may be suitable if they are designed to supply washing machines. (Check your boilers operation instructions or supplier.)

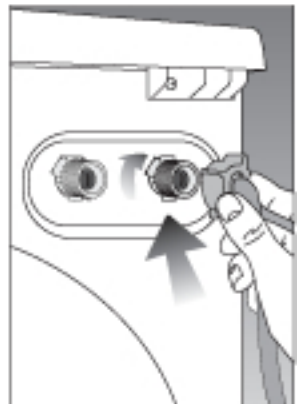

Connect the cold water using the hose with blue printing and connect the hot water using the hose with red printing.



## b) Water drain hose

Water drain hose could be placed either at the side of the laundry tub, or directly to the drain. The hose should not be bent. Water drain hose should be secured with the elbow so that it would not fall down on the ground.



The hose should be placed between 40 and 100 cm. from the ground.

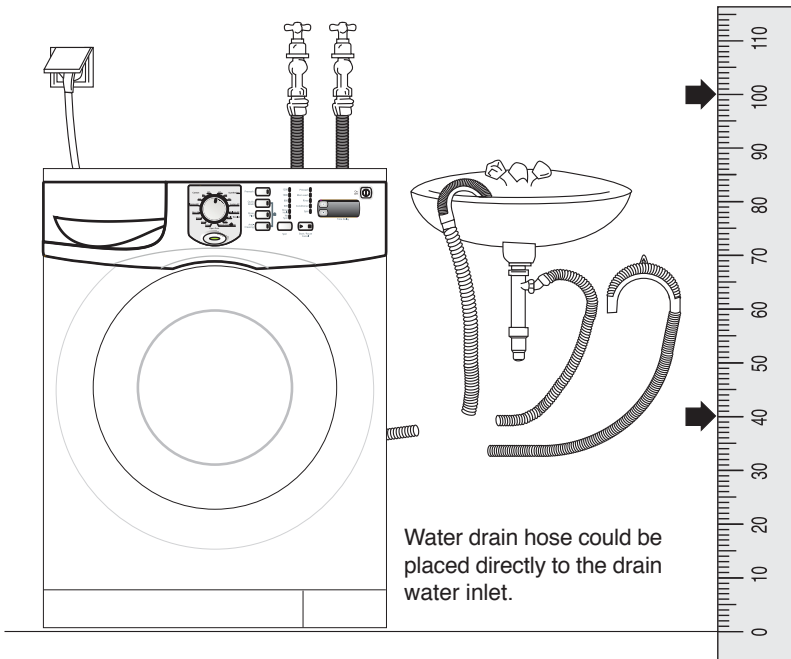

## 4. Electrical connection

Connect the power cord to the appropriate electrical system which is being supported by the maximum voltage and current rating indicated on the rating plate placed inside the kick plate.

Note! Page 1, Steps before operating fully automatic Washing Machine and safety precautions.

## Part 4: Preparation

● Attention! Before any operation of the machine check the following.

- Did you close the front door?
- Is the tap open?
- Is water drain hose placed properly?
- Is power connected?

● Sorting laundry

Sort the laundry according to the following groups and wash them separately:

- white and resistant colored fabrics,
- colored fabrics,
- delicate fabrics (silk, rayon etc.),
- wool.

Be sure to empty pockets and remove any belts, buttons, pins, etc. from the clothing. You can place smaller garments (baby socks, etc) inside of pillow cases to avoid them slipping into the pump and filter. For stained fabrics, refer to the “Practical information” section of the operating manual.

● To open the front door

press the “door open” button.

For your safety, front door can be opened only when the machine is off.

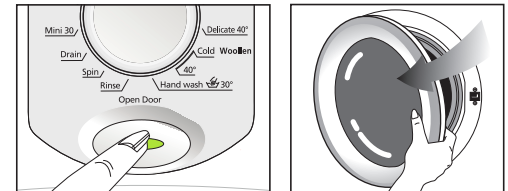

● Loading the machine

Place the garments uniformly inside the machine. Hand knits should be placed inside out in the machine. Make sure that there is no clothing at the side of the door. Close the door by pushing lightly. If the door does not close completely, the machine could will not start, this is a safety measure. The door is locked until the end of the washing program and it cannot be re-opened until about 2 minutes following the end of the program.

## ● Detergent and softener selection

Choose the appropriate detergent specifically used for FRONT LOAD washing machines. Suggested amount is given on the detergent cover.

Do not attempt to use detergents and bleaching elements that contain chlorine and sulphur. The amount of the detergent depends on the dirt level of fabric, the amount of fabric and the softness of the water.

## ● Detergent Dispenser

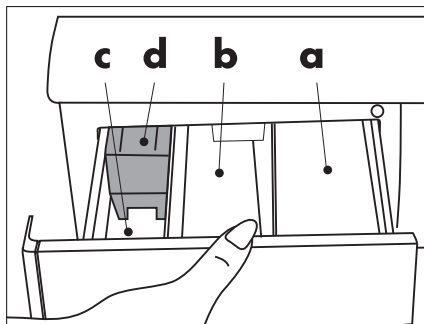

- a. Compartment I. detergent compartment for prewash cycle.
- b. Compartment II. detergent compartment for wash cycle.
- c. "☐" Compartment for fabric conditioner.
- d. Siphon.



**WARNING!**  
When the CURTAIN program is selected Pre-wash function is automatically set. Pre-wash can be operated even without detergent.



**Attention!** Fill the softener according to the supplier recommendation (app. <100 ml). Do not exceed the "MAX level" marked on the detergent dispenser.

# Control Panel

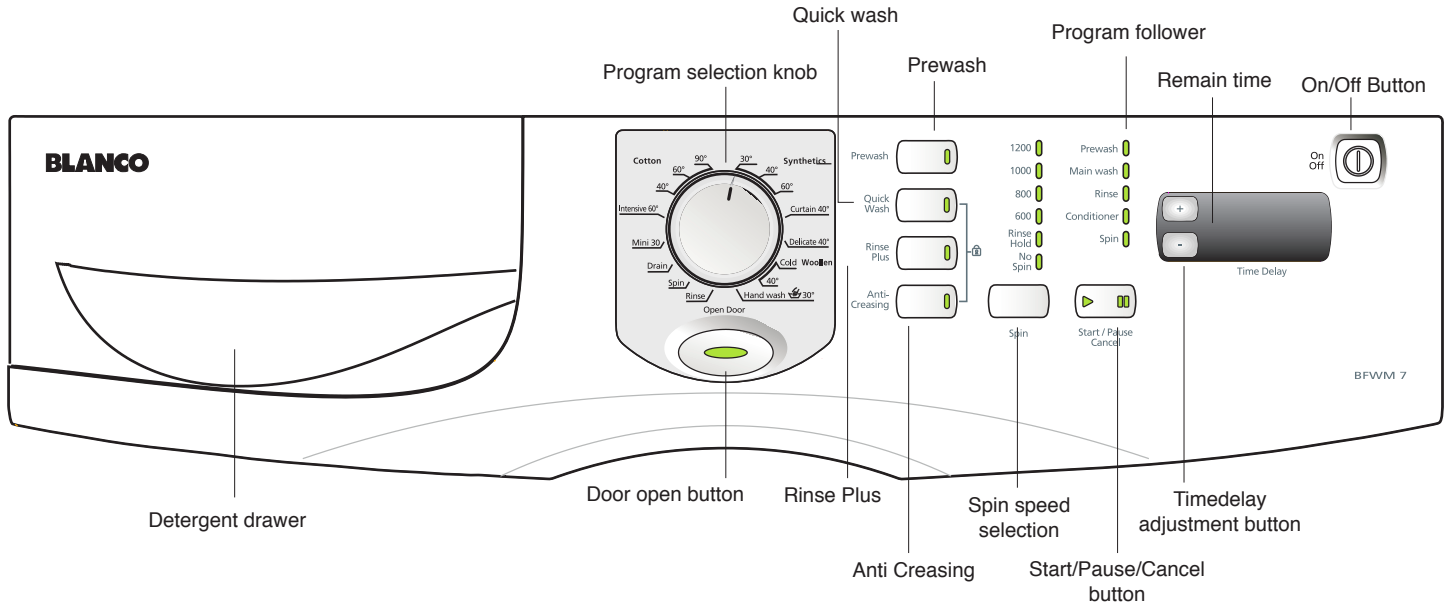

### Prewash

A pre-wash is only worth while with heavily soiled laundry. Without prewash you save energy, water, washing powder and time.

### Quick wash

Shortens washing time for lightly soiled fabrics. This function can be used for cotton and synthetic programs for temperatures below 60° C.

### Rinse plus

By using this function your machine will add another rinse process to the three rinse processes that it has already done. This additional rinse will reduce any affects on sensitive skin by washing leftover detergent.

### Anti Creasing

To avoid wrinkling of your clothes, select this function. When Anti-Creasing is choosen please load less cloth, this way a special washing and spinning profile will reduce the wrinkles and your clothes will be easy to iron.

### Spin Speed Selection

Using this button, you can select final spin speed upto 1200 rpm. If you do not want to apply spinning to your clothes, select “No Spin” option.

### Rinse Hold

If you desire to leave your synthetic and wool fabrics in the machine after the wash program you may select the Rinse hold option to prevent them getting wrinkled. If you want to cancel the “Rinse Hold” function, you have to press on “Start/Pause/Cancel” button first, select the desired spin speed and then repress on the “Start/Pause/Cancel” button.

# Part 5: Program Selection and Washing Machine Operation

Insert the plug. Press the On/Off button and then the Door Open button. Open the door. Place your laundry into the machine according to the recommended load capacity and close the front door.

Select the proper program according to the dirt strength and the thermostat value by means of Program Selection Table given on the following pages.

Turn the program selection knob and set the desired program. Select the spin speed according to the desired program. Select desired auxiliary functions.

Then, fill the fabric softener and the detergent into the related compartments, and close the detergent dispenser box. Push the Start/Pause button to operate your machine. In the mean time the Start/Pause LED  will be on. You can follow the washing steps by means of the program follower.

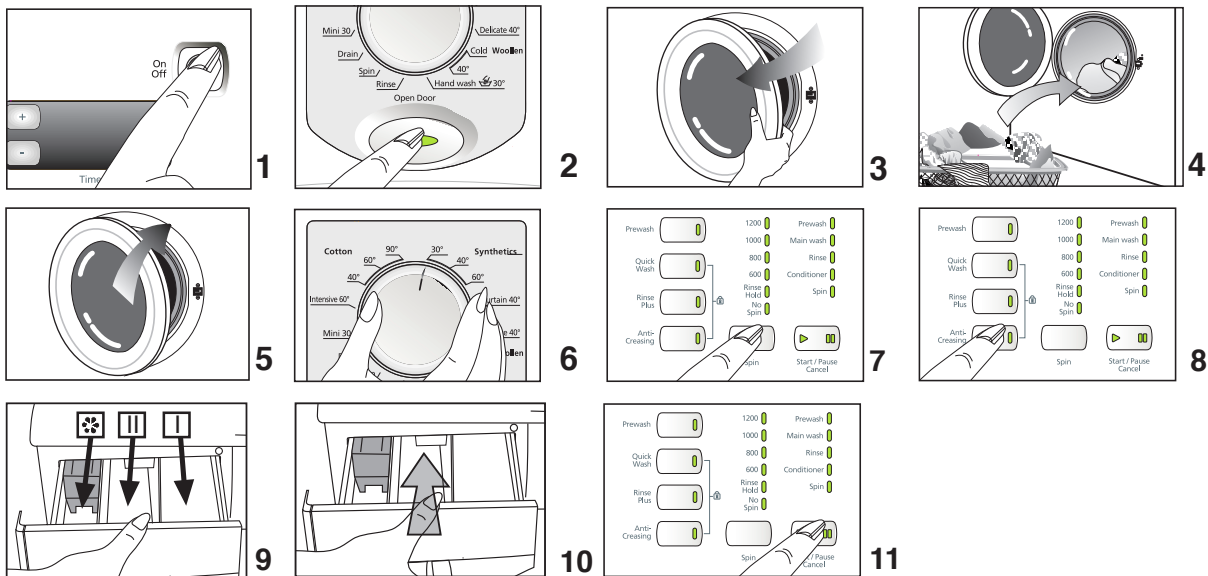

## Program selection

Programme	Fabric type	Max Load (kg)	Program Duration (~min)	Water Consumption (l)	Energy Consumption (kWh)	Prewash	Quick Wash	Rinse Plus	Rinse Hold	Anti-Creasing	Detergent Dispenser
Cotton 90	Heavy soiled fabrics made from cotton or linen, heat resistant	7	139	55	2.26	•	•	•	•	• (capacity 2.5kg)	I+II
Cotton 60*	Normal soiled fabrics made from cotton or linen, heat resistant	7	140	49	1.19	•	•	•	•	• (capacity 2.5kg)	I+II
Cotton 40	Lightly soiled fabrics made from cotton, non-color fast	7	142	49	0.50	•	•	•	•	• (capacity 2.5kg)	I+II
Intensive 60	Heavy soiled fabrics made from cotton or linen, heat resistant	7	175	70	1.35			*	•	• (capacity 2.5kg)	II
Synthetics 60	Normal soiled fabrics made from cotton/synthetics blended, heat resistant	3	103	50	1.02	•	•	•	•	• (capacity 1.5kg)	I+II
Synthetics 40	Lightly Soiled Easy care fabrics made from cotton, synthetics or blended fabrics (non-color fast)	3	100	50	0.50	•	•	•	•	• (capacity 1.5kg)	I+II
Synthetics 30	Very Lightly Soiled Easy care fabrics made from cotton, synthetics or blended fabrics (non-color fast)	3	81	50	0.16	•	•	•	•	• (capacity 1.5kg)	I+II
Curtain 40	Special programme for curtains	2	115	65	0.55	*		*	•	* (capacity 2kg)	I+II
Delicate 40	Sensitive, easy care fabrics made from cotton, synthetics or blended fabrics	2	62	60	0.35			•	•	• (capacity 1kg)	II
Woollen 40	Hand wash marked easy care, blended fabrics	1.5	55	50	0.35			•	•		II
Woollen Cold	Hand wash marked wool and easy care, blended fabrics	1.5	48	50	0.04			•	•		II
Handwash 30	Special programme for Hand wash marked wool and silk	1	40	40	0.15						II
Mini 30	Lightly Soiled less amount fabric	2.5	30	50	0.15						II
Rinse	Rinsing	7	23	15	0.12						-
Spin	Spinning	7	19	-	0.1						-
Drain	Draining	-	2	-	-						-

Depending on water, textile and ambient conditions the actual values given on or with the machine can deviate from the declared standard values, as they are tested according to the laboratory conditions

# Child Lock

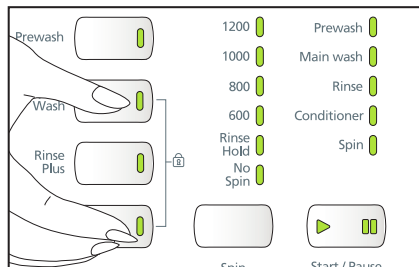

To prevent the knobs from being played with by your children you may activate “child lock” option. Activating the “Child Lock” option prevents any change from being made to a set program.

To activate child lock, press both on the second and the fourth auxiliary function buttons together for 3 seconds after the machine starts the washing operation.

After activating the Pre-wash auxiliary function, the LED will be blinking.

Only On/Off button will be in operation when the child lock option is selected.

To deactivate child lock, re-press same auxiliary function buttons (second and fourth) for 3 seconds.

In order to open the door at the end of the washing program or to change program selection, child lock must be deactivated if selected.



When the machine is turned on, the LED of the selected program will light up.

If there is no light on the program selection knob, it means that program selection knob is stuck between two programs. In that case, the knob should be adjusted on the correct program again.

If the program selection knob is turned while the machine is on and executing the selected program, all LED on the program selection knob will be off. When the knob is set to selected program again, related LED will be on.



## On/Off

When you press the On/Off button, your machine is ready to select the desired program. The “door open” LED will be on and the door is ready to open. When the desired program is selected, related spin speed can be adjusted and the duration of the program can be observed on the display. To switch the machine off, repress the On/Off button.

Washing can only then be started when the  button is pressed.

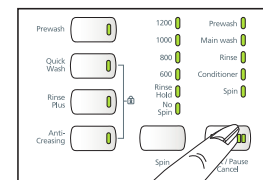
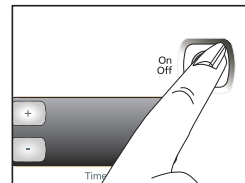

Pressing the On/Off button does not mean that the washing operation is started!  
To start the washing, press the Start/Pause button!

## Auxiliary Function Selection

It is not possible to activate all auxiliary functions in all wash programs. If any auxiliary function is selected, its LED will be on. It is restricted to select some auxiliary functions together. For example, if the cotton program is selected, “quick wash” and “pre-wash” functions can not be selected at the same time. If “Pre-wash” button is selected first and the “Quick wash” function next, the LED of the pre-wash function will be off as it is not active any more.

## Program Follower

If the machine is on, a program can be followed by means of the program follower. If a washing step is over and the next step is started, the LED of the previous step will continue to light.

It means if the washing operation is finished, all related washing steps on the program follower will be on. Pre-wash button LED will be on, only if this auxiliary function is selected.

## Additional Laundry

Press the Start/Pause button. If the water level does not exceed the limitations, in 1 to 2 minutes door open LED will come on. It means the washing machine is ready to add laundry.

If door open LED is not lit up after 1-2 minutes, it means the water level inside the machine is too high and you will not be able to open the door and add laundry. (Look at Program Cancelling).

If you change your mind and decide not to add laundry, press Start/Pause button again to let the program continue.

## End of the Program

If all the wash programs are finished, all the LEDs on the program follower will be on. "1-2 minutes" for door open is displayed on remain time display. After 1-2 min door open LED will light up.

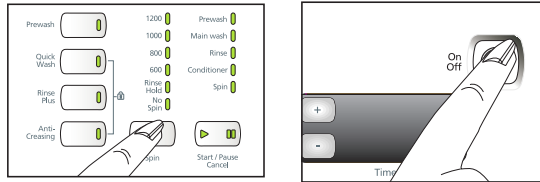

At the end of the washing, all related LEDs on the control panel will be on. Related duration time of the selected program is displayed and the machine is ready to start again.  
To switch off the machine, press the On/Off button.

## Unloading the machine

Machine stops automatically after all the programs are finished. Turn off the tap. In 1-2 min, after the door open LED lights up, press the door open button and open the door. Press the On/Off button to switch off the machine.  
Unload the machine and leave the front door open. Check to see if there is any water left in the door hood. If so, remove with a soft cloth.

## Time Delay

By using the time delay buttons, starting time of any program can be delayed. Time delay can be set at intervals of 30 min.

On the display, the delayed starting time is added to the duration of the program.

For example, if the program duration is 2 hours and 16 min and you delayed the program for 2 hours, the display will show "4:16". After the time delay is set, press Start/Pause button. The washing period will be started after 2 hours

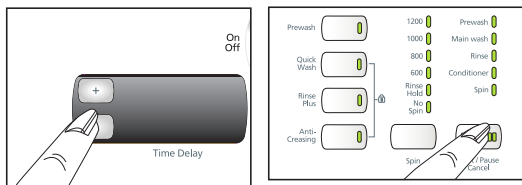

## Program Cancellation

If the program has not started yet, you can cancel the selected program by pressing Start/Pause button for 3 seconds. After 3 seconds the LED of the Start/Pause button will be off and the LED of the selected program will be on, where it is possible to set a new program

If the program has started and you want to cancel it, press Start/Pause button for 3 seconds. The program will move to the "spin" step and related LED on the program follower will be on. Machine will start to pump for draining and the door can be opened after the door open LED is on.

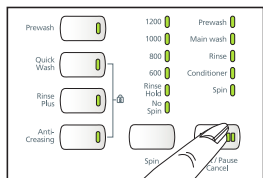



### Detergent dispenser

To clean the detergent residues, remove the detergent dispenser from its place by pressing on the area marked on siphon. Wash the dispenser with water and also clean the dispenser housing before inserting the dispenser to its place.

Leave the door slightly ajar when not in use. This preserves the door seal and prevents the formation of musty smells.

### Siphon

Clean the siphon (coloured piece in the dispenser) every 30-40 washes. Pull out the siphon by holding from its edges. To prevent clogging, clean the softener residues thoroughly and make sure that the siphon fits into its place completely before any operation.

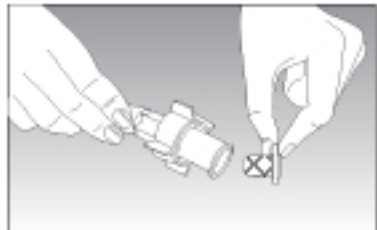

### Water intake filter

At the end of the water intake connection module and water inlet hose-tap side, there exists filters. These filters prevent any dirt and objects passing into the machine. It is advisable that these filters should be cleaned every 30-40 washes. To clean the filter, first turn the tap off. Then, disconnect the hose and clean the filter with a thin brush. If the filter is very dirty, you may clean it by pulling out with pliers. To clean the filter at the tap side of the hose, pull it out by hand and clean the filter under the tap water.

### Hose

To prevent any leakage, have a technician replace the hoses every two years. If the machine is placed at cold ambient temperatures, the water remaining inside the pump and hoses should be removed from the filters. Also to prevent freezing, empty the water intake hoses by disconnecting from taps.

### Drum

Do not leave any metal objects (pins, needles, etc.) inside the drum. These objects may cause rust on the drum surface. Do not clean the drum with scratching elements.

Remove the electrical power plug. Open the open the Kick plate cover located at the bottom right side of the machine by pushing on the marked area shown beside.



Attention! Hot water danger! It is possible that app. 15 lt, 90°C hot water is inside. Be careful while taking out the filter!

Before taking out the filter, drain the water by means of pump drain hose. Take out the pump drain hose from its place. Place a shallow container under the pump hose to catch the water. Remove the drain pump hose plug and drain the water.

When all water is discharged, insert the plug into the pump hose again and replace the pump drain hose in its place.

Open the filter while turning it counterclockwise, drain the left water (max 30 ml) on to the filter cover. If there are any residual parts inside the filter, take them out and clean the filter before replacing it. Then, place the filter while turning it clockwise and at the end, close the filter cover by pushing on the marked area again.



Attention! The filter and hose plug must be replaced correctly. Ensure there is no lint around the seal of the filter which could cause leaking.

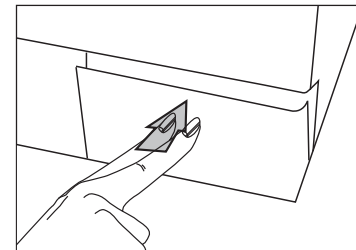
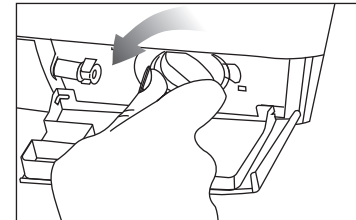
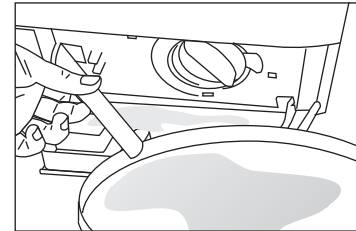
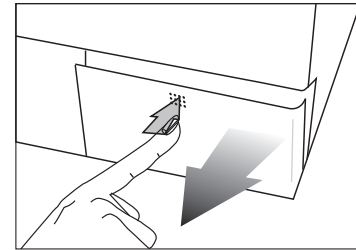

## Part 7: | Before calling service



You turned the machine on, but the LEDs do not light up on the panel.

Check that the power cord is plugged in and power is turned on or a blown fuse. Check the front in closed properly closure.



Machine does not take water.

Check the front door for proper closure. Either taps are closed or water intake filters are clogged.



Taken water is directly discharged.

Check if the discharge hose placed as described in the users manual or not.



Water coming from beneath the machine.

Check the water intake and drain hoses. Tighten the connections. The washers of the hoses may be worn out. If non of the two, the pump filter is not closed properly.



Foam coming out of the detergent dispenser.

Check whether your detergent is suitable for FRONT LOAD machines. Next time use less detergent.



Pump does not drain water.

Clean the pump filter. Check whether the drain hose is bent or not. If there is need to clean the pump filter, refer to the pump filter cleaning section of the manual.

### Descriptions of the international textile care label (ITCL) symbols



Washing temperature

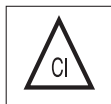

Bleach can be used



Do not use bleach



Do not machine wash

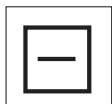

Dry on horizontal surface



Do not wash



Dry clean

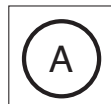

Chemicals can be used



No dry cleaning



No spin



Can be washed at centrifugal machine



Do not wash centrifugal machine



Line dry



Iron permitted



Do not iron



Warm iron

## Blanco Contact Information.

### NEW SOUTH WALES

#### Head Office, Sales & Marketing Office

104 Vanessa Street  
Kingsgrove NSW 2208  
Telephone: 02 9503 2888  
Facsimile: 02 9503 2810

#### NSW Showroom\*

40 Ebley Street  
Bondi Junction NSW 2022  
Telephone: 02 9386 1190  
Facsimile: 02 9386 1671

#### Agent and Sales Office.

Hi –Performance Marketing  
7 Coleman Street  
Mascot NSW 2020  
Telephone: 02 88354937  
Facsimile: 02 90048739

#### Service and Spare Parts

All General Whitegoods Service  
Telephone: 02 8788 8666  
Facsimile: 02 9756 1091

### AUSTRALIAN CAPITAL TERRITORY

#### Service and Spare Parts

Detlevs Appliance & Electrical Care  
1/88 Sheppard Street  
Hume  
ACT 2905  
Telephone: 02 6280 1033  
Facsimile: 02 6260 1035

### VICTORIA

#### State Office and Showroom\*

35 Centre Road  
Scoresby VIC 3179  
Telephone: 03 8756 7888  
Facsimile: 03 8756 7907

#### Service and Spare Parts

Advantage Appliances  
Telephone: 03 9874 4222  
Facsimile: 03 9874 6917

### QUEENSLAND

#### State Office and Showroom\*

148 Robinson Road - East  
Geebung  
QLD 4034  
Telephone: 07 3259 2500  
Facsimile: 07 3265 6933

#### Endeavour Appliances

Telephone: 07 3872 7444  
Facsimile: 07 3852 2465

#### Platinum Appliance Service.

Telephone: 07 38621154  
Facsimile: 07 38621114

### SOUTH AUSTRALIA & NORTHERN TERRITORY

#### Agent and Sales Office

S C Lighting & Electrical Supplies  
47 North Terrace  
Hackney SA 5069  
Telephone: 08 8362 4599  
Facsimile: 08 8362 4591

#### Service and Spare Parts

Prestige Appliance Repair Centre  
Telephone: 08 8352 2022  
Facsimile: 08 8352 3044

### WESTERN AUSTRALIA

#### Agent and sales Office

Elite Appliance Marketing Pty Ltd  
Suite 4  
14 Main Street  
Osborne Park WA 6017  
Telephone: 08 9201 0311  
Facsimile: 08 9201 0366

#### Service and Spare Parts

Metropolitan Appliance Repairs  
Telephone: 08 9330 1724  
Facsimile: 08 9317 1296

### TASMANIA

#### Agent and Sales Office

Mark Pearce Agencies  
23 Tranmere Road  
Howrah TAS 7018  
Tel/Fax: 03 6247 9215

#### Service and Spare Parts

Electrical Equipment Service (Launceston)  
Telephone: 03 6339 3873  
Facsimile: 03 6339 4588

#### Baldocks Appliance Service (Hobart)

Telephone: 03 6234 5995  
Facsimile: 03 6234 8134

## BLANCO CUSTOMER SERVICE 1300 739 033

Website: [www.meappliances.com.au](http://www.meappliances.com.au)

\* Showrooms open six days a week